

Applications

- Liquid Service
- Process Industry
- Power Industry
- Chemical Industry
- Metals & Mining
- Water & Waste Water
- Pulp & Paper
- Oil & Gas

Wafer Silent Check Valves

Pressures to 740 PSIG
Temperatures to 400°F

FEATURES

- Silent Non-slam Closure
- Wafer Body Style
- Reduces surge and water hammer

MATERIALS

- Cast Iron Body;
Bronze & Stainless Steel Disc
- Cast Steel Body;
Stainless Steel Disc
- Stainless Steel;
Stainless Steel Disc

WAFER SILENT
CHECK VALVES

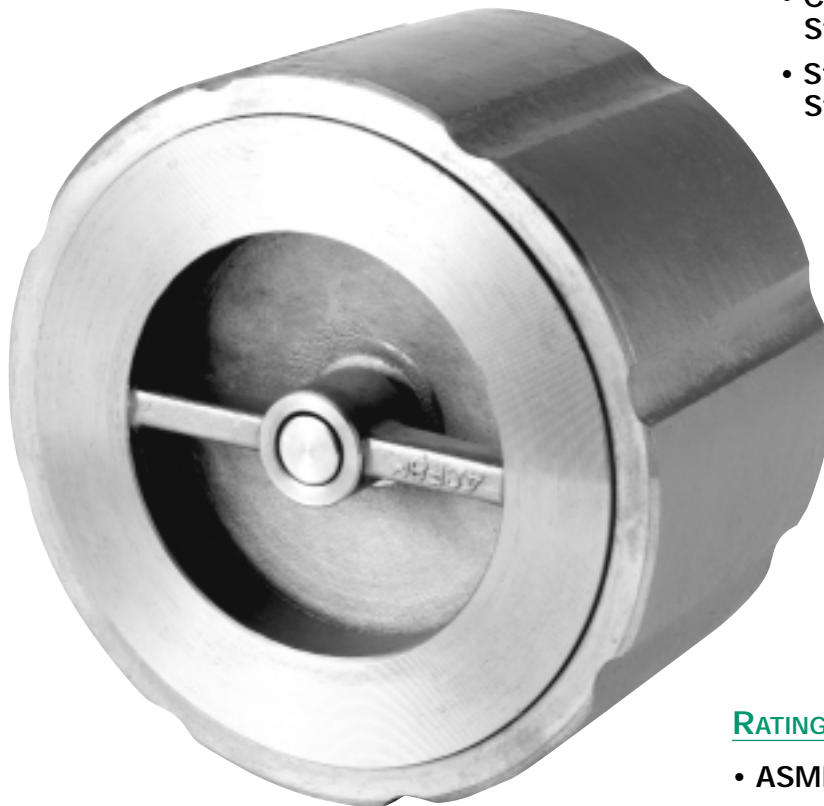

END CONNECTIONS

- Wafer Flat Faced
- Wafer Raised Face

SIZES

- 2" (50mm)
up to 12" (300mm)

RATINGS

- ASME Class 125
- ASME Class 150
- ASME Class 300



125WC SERIES

CAST IRON WAFER SILENT CHECK VALVES

Pressures to 200 PSIG (13.8 barg)
Temperatures to 300°F (149°C)

APPLICATIONS

- Liquid Service
- Process Industry
- Power Industry
- Chemical Industry
- Oil & Gas
- Pulp & Paper
- Metal & Mining
- Water & Waste

- **ASME Class 125 rated check valves**
- **Designed to reduce surge and water hammer**
- **Silent, non-slam closure**
- **Center guided at both ends to prevent binding and cocking**
- **Compact face to face length for space saving**
- **Wafer body style fits between FF or RF flanges**

MODELS

- 125WCIB - Cast Iron Body, Bronze Disc
- 125WCIT - Cast Iron Body, Stainless Steel Disc

OPTIONS *(Consult factory)*

- EPDM Seats
- Other Spring Material
- Heavier or Lighter Springs

APPLICABLE CODES

- ASME Sec VIII and B16.1 Bodies
- API 598

Canadian Registration - OC10274.5C

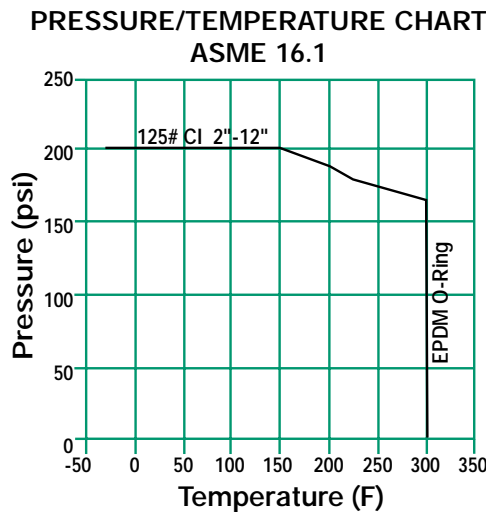

125WC Series Ordering Code

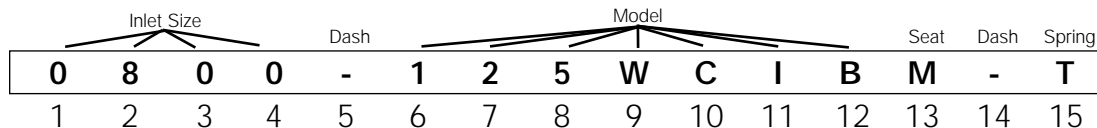

<b style="color: #008080;">Inlet Size - Position 1 - 4 0200 - 2" 0250 - 2½" 0300 - 3" 0400 - 4" 0500 - 5" 0600 - 6" 0800 - 8" 1000 - 10" 1200 - 12"
--

<b style="color: #008080;">Dash - Position 5 <b style="color: #008080;">Model - Position 6 - 12 125WCIB - Cast Iron Body, Bronze Disc 125WCIT - Cast Iron Body, Stainless Steel Disc <b style="color: #008080;">Seat - Position 13 M - Metal <b style="color: #008080;">Dash - Position 14 <b style="color: #008080;">Spring - Position 15 T - Stainless Steel
--



125WC SERIES CAST IRON WAFER SILENT CHECK VALVES

SPECIFICATION

Check Valve shall be single disc design with Cast Iron wafer body style designed to ASME Sec. VIII and ASME B16.1. The check valve shall have a metal to metal seat with bronze or SS discs and be center guided from both ends. The check valve shall be ASME Class 125 rated. The spring shall be 316SS. The check valve shall be SSI 125WC Cast Iron Series.

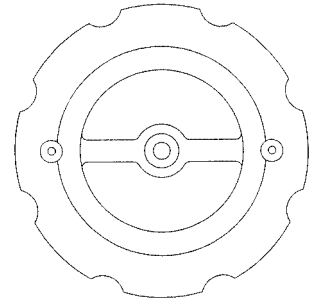

MATERIALS OF CONSTRUCTION

BodyA126-B Cast Iron
 DiscsAl/Bz B148 C954 or 316SS A351-CF8M
 SeatBronze or SS
 Spring316SS
 O-RingEPDM

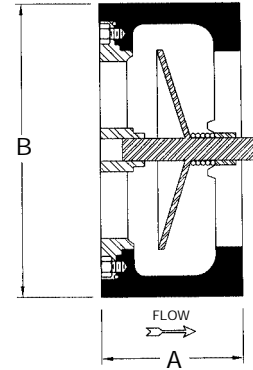

DIMENSIONS inches (mm) AND WEIGHTS pounds (kg)

Size	A	B*	QTY	Stud Selection		Weight
				Dia.	Length	
2 (50)	2 ¹¹ / ₁₆ (68)	4 ¹ / ₈ (105)	4	⁵ / ₈ (16)	6 ¹ / ₂ (165)	5 (2.3)
2 ¹ / ₂ (65)	2 ⁷ / ₈ (73)	4 ⁷ / ₈ (124)	4	⁵ / ₈ (16)	6 ³ / ₄ (171)	8 (3.6)
3 (80)	3 ³ / ₁₆ (81)	5 ³ / ₈ (137)	4	⁵ / ₈ (16)	7 (178)	10 (4.5)
4 (100)	4 (103)	6 ⁷ / ₈ (175)	8	⁵ / ₈ (16)	8 (203)	19 (8.6)
5 (125)	4 ⁵ / ₈ (118)	7 ³ / ₄ (197)	8	³ / ₄ (19)	8 ³ / ₄ (222)	30 (13.6)
6 (150)	5 ⁹ / ₁₆ (142)	8 ³ / ₄ (222)	8	³ / ₄ (19)	10 ¹ / ₂ (267)	42 (19.1)
8 (200)	6 ¹ / ₂ (165)	11 (279)	8	³ / ₄ (19)	11 ¹ / ₄ (286)	87 (39.5)
10 (250)	8 ⁷ / ₃₂ (209)	13 ³ / ₈ (340)	12	⁷ / ₈ (22)	12 ¹ / ₄ (311)	146 (66.2)
12 (300)	11 ¹ / ₄ (286)	16 ¹ / ₈ (410)	12	⁷ / ₈ (22)	16 ¹ / ₂ (419)	304 (137.9)

*Add the "B" dimension and the diameter of the stud to achieve the ANSI B16.5 Bolt Hole Circle Diameter

- Connections: 2" to 12" Flanged FF
- Seats: 2" to 12"
Bronze or Stainless Steel
- Cracking Pressure:
Horizontal Mounting - .3 psid
Vertical Mounting - .75 to 1.25 psid

WAFER SILENT CHECK VALVES

125WC SERIES WAFER SILENT CHECK VALVE

PRESSURE DROP VS FLOW RATE

(Sizes 2" - 12")

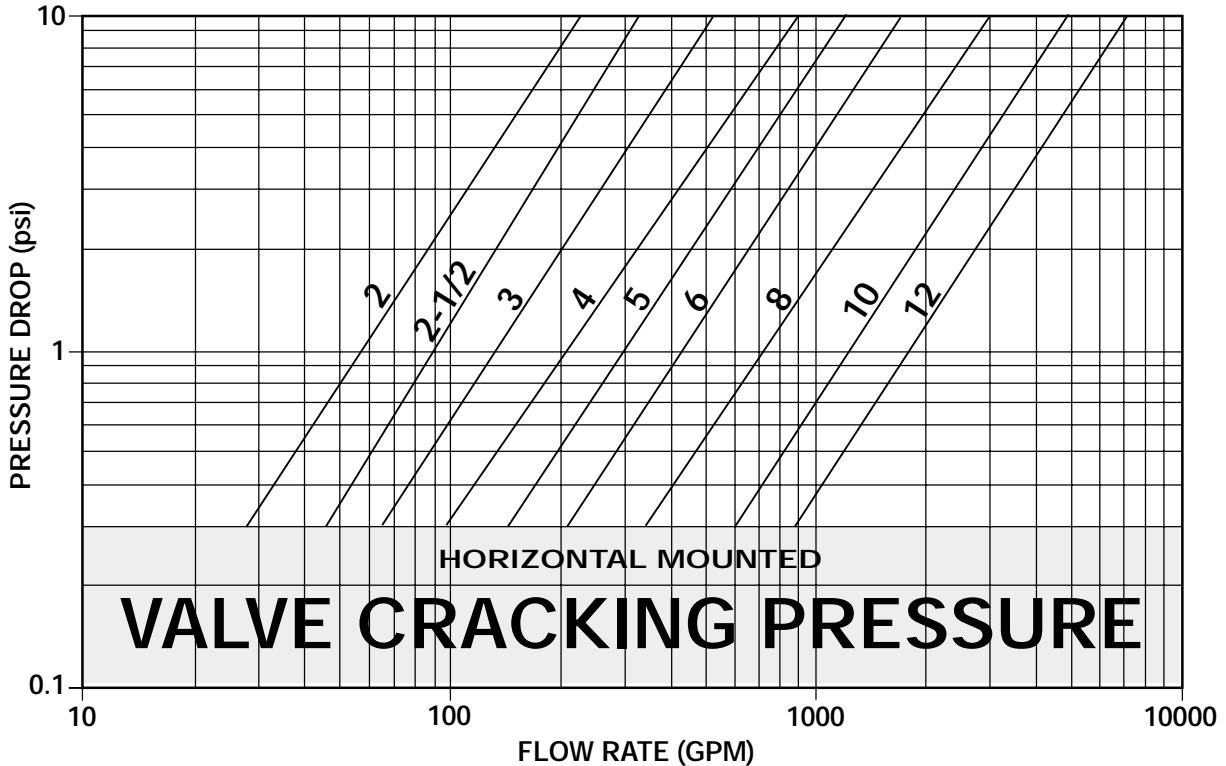

- (1) Pressure drop curves are based on water flow.
- (2) Valve cracking pressure is equal to or less than 0.3 psid when mounted horizontally.
- (3) Valve cracking pressure increases to between 0.75 and 1.25 psid when installed vertically with flow upwards.

Installation Note:

1. For correct installation and maintenance please see our I&M manual.
2. Vertical installation (downward flow) – Consult factory.
3. Always use Strainers in upstream piping.
4. Not recommended for Steam Service

Cv Values

Size (inches)	2	2½	3	4	5	6	8	10	12
Min Cv (@ .3 PSID)	51	84	119	179	265	383	639	1114	1604
Cv (@ 1 PSID)	58	90	134	210	300	430	740	1250	1800
Max Cv (@ 10 PSID)	73	106	168	285	391	548	964	1581	2277



NOTES:

WAFER SILENT
CHECK VALVES





150WC SERIES

CAST STEEL AND STAINLESS STEEL WAFER SILENT CHECK VALVES

Pressures to 285 PSIG (19.7 barg)
 Temperatures to 400°F (204°C)

APPLICATIONS

- Liquid Service
- Process Industry
- Power Industry
- Chemical Industry
- Oil & Gas
- Pulp & Paper
- Metal & Mining
- Water & Waste

- ASME Class 150 rated check valves
- Designed to reduce surge and Water Hammer
- Silent, non-slam closure
- Center guided at both ends to prevent binding and cocking
- Compact face to face length for space saving
- Wafer body style fits between FF or RF flanges
- Dual rating 150# and 300# in sizes 2" through 6"

MODELS

- 150WCCT – Cast Steel Body, Stainless Steel Disc
- 150WCST – Stainless Steel Body, Stainless Steel Disc

OPTIONS *(Consult factory)*

- Viton Seats
- Other Spring Material
- Heavier or Lighter Springs

APPLICABLE CODES

- ASME Sec. VIII and B16.34 Bodies
- API 598

Canadian Registration - OC10274.5C

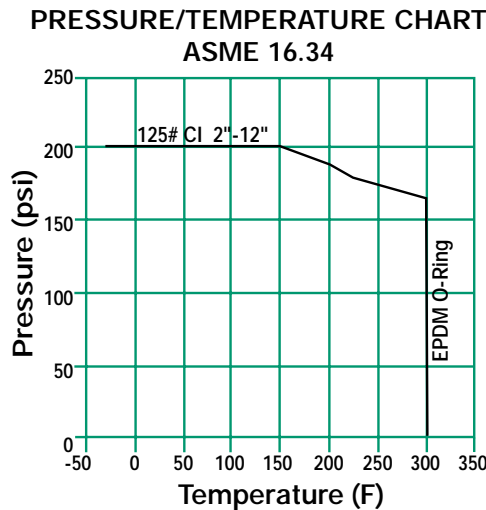

150WC Series Ordering Code

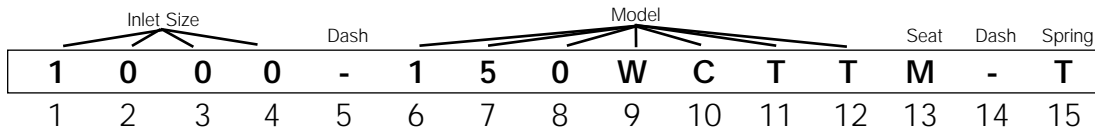

Inlet Size* - Position 1 - 4 2" through 6" sizes use 300WC Series 0800 - 8" 1000 - 10" 1200 - 12"
Dash - Position 5
Model - Position 6 - 12 150WCCT - Cast Steel Body, Stainless Steel Disc 150WCST - Stainless Steel Body, Stainless Steel Disc

Seat - Position 13 M - Metal
Dash - Position 14
Spring - Position 15 T - Stainless Steel

150WC SERIES CAST STEEL AND STAINLESS STEEL WAFER SILENT CHECK VALVES

SPECIFICATION

Check Valve shall be single disc design with Cast Steel or Stainless Steel wafer body style designed to ASME Sec. VIII and ASME B16.34 and API 594. The check valve shall have a SS seat and disc and be center guided from both ends. The check valve shall be ANSI 150 PSIG rated. The spring shall be 316SS. The check valve shall be SSI 150WC Cast Steel or Stainless Steel Series.

MATERIALS OF CONSTRUCTION

Part	Carbon Steel	Stainless Steel
Body	A216-WCB	A351-CF8M
Discs	A351-CF8M	A351-CF8M
Seat	A351-CF8M	A351-CF8M
Spring	316SS	316SS
O-Ring	Viton	Viton

DIMENSIONS inches (mm) AND WEIGHTS pounds (kg)

Size	A	B*	QTY	Stud Selection		Weight
				Dia.	Length	
2' (50)	Use 2" 300WC on page 205					
2½' (65)	Use 2½" 300WC on page 205					
3' (80)	Use 3" 300WC on page 205					
4' (100)	Use 4" 300WC on page 205					
5' (125)	Use 5" 300WC on page 205					
6' (150)	Use 6" 300WC on page 205					
8 (200)	6½ (165)	11 (279)	8	¾ (19)	11¼ (286)	79 (35.8)
10 (250)	8¼ (209)	13¾ (340)	12	7/8 (22)	12¼ (57)	147 (66.7)
12 (300)	11¼ (286)	16½ (410)	12	7/8 (22)	16½ (165)	280 (127)

1. Sizes 2" through 6" 150WC and 300WC are interchangeable, use 300WC for all applications in these sizes.

* Add the "B" dimension and the diameter of the stud to achieve the ANSI B16.5 Bolt Hole Circle Diameter.

Dimensions are subject to change. Consult factory for certified drawings when required.

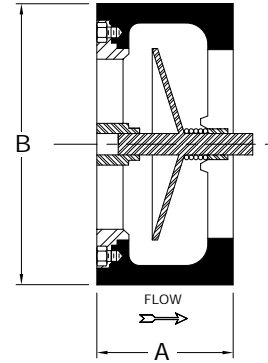
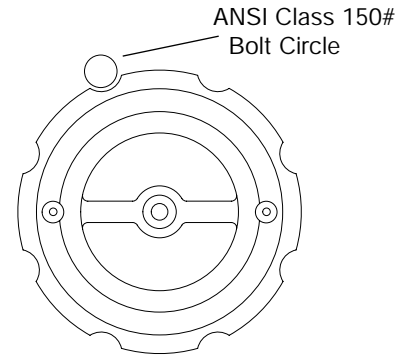

Connections: 8" to 12"
Wafer Flanged RF*

* For sizes 2"-6" use 300WC on page 205

Seats: 8" to 12" Stainless Steel

Cracking Pressure:
Horizontal Mounting - .3 psid
Vertical Mounting - .75 to 1.25 psid

WAFER SILENT
CHECK VALVES

150WC SERIES CAST STEEL & STAINLESS STEEL WAFER SILENT CHECK VALVES PRESSURE DROP VS FLOW RATE (Sizes 8" - 12")

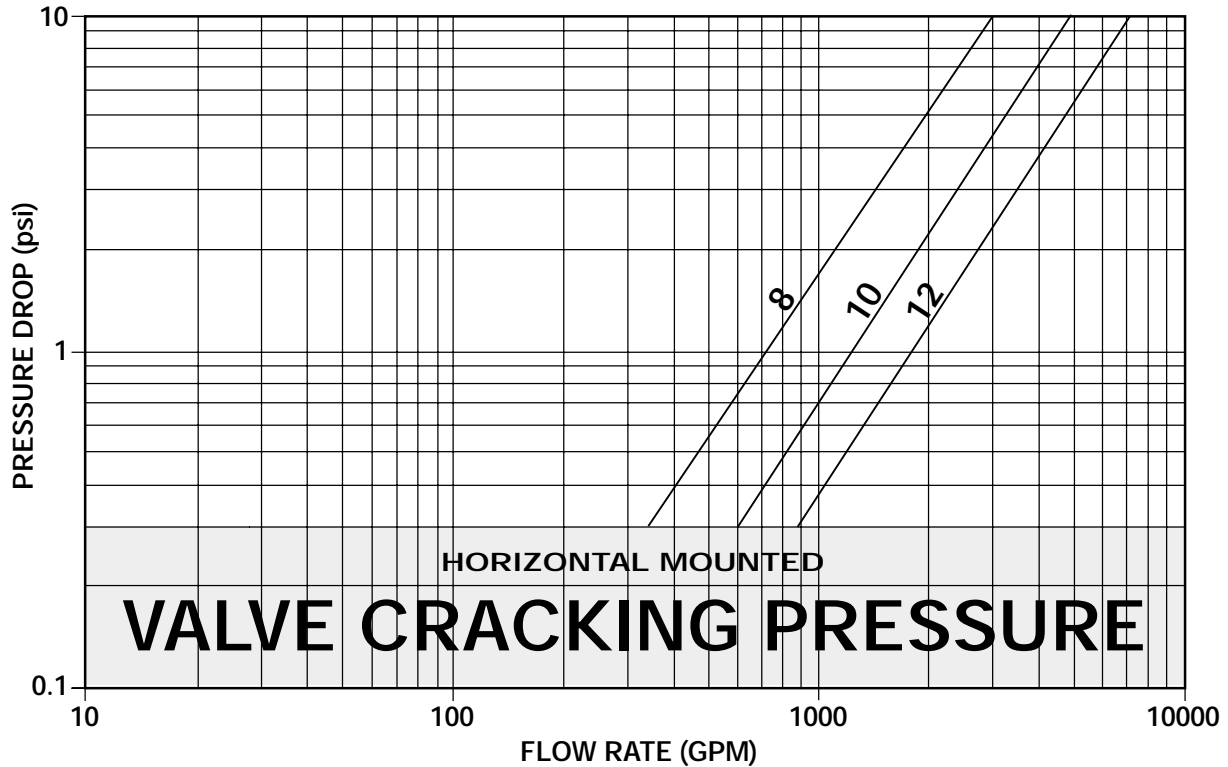

- (1) Pressure drop curves are based on water flow.
- (2) Valve cracking pressure is equal to or less than 0.3 psid when mounted horizontally.
- (3) Valve cracking pressure increases to between 0.75 and 1.25 psid when installed vertically with flow upwards.

Installation Note:

1. For correct installation and maintenance please see our I&M manual.
2. Vertical installation (downward flow) – Consult factory.
3. Always use Strainers in upstream piping.
4. Not recommended for Steam Service.

Cv Values

Size (inches)	8	10	12
Min Cv (.3 PSID)	639	1114	1604
Cv (@ 1 PSID)	740	1250	1800
Max Cv (@ 10 PSID)	1297	1992	2593



WAFER SILENT CHECK VALVES

NOTES:

WAFER SILENT
CHECK VALVES





300WC SERIES

CAST STEEL AND STAINLESS STEEL WAFER SILENT CHECK VALVES

Pressures to 740 PSIG (51 barg)
Temperatures to 400°F (204°C)

APPLICATIONS

- Liquid Service
- Process Industry
- Power Industry
- Chemical Industry
- Oil & Gas
- Pulp & Paper
- Metal & Mining
- Water & Waste

- ASME Class 300 rated check valves
- Designed to reduce surge and Water Hammer
- Silent, non-slam closure
- Center guided at both ends to prevent binding and cocking
- Compact face to face length for space saving
- Wafer body style fits between FF or RF flanges
- Dual rating 150# and 300# in sizes 2" through 6"

MODELS

- 300WCCT – Cast Steel Body, Stainless Steel Disc
- 300WCTT – Stainless Steel Body, Stainless Steel Disc

OPTIONS *(Consult factory)*

- Viton Seats
- Other Spring Material
- Heavier or Lighter Springs

APPLICABLE CODES

- ASME Sec. VIII and B16.34 Bodies
- API 598

Canadian Registration - OC10274.5C

**PRESSURE/TEMPERATURE CHART
ASME 16.34**

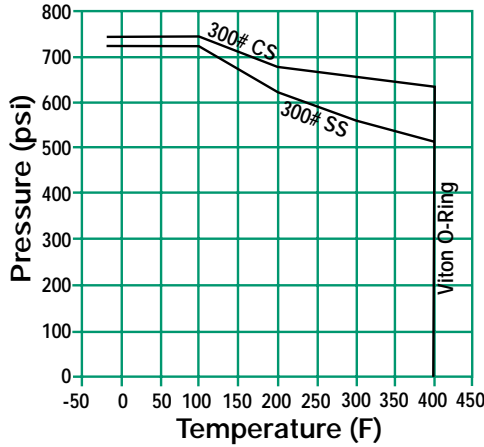

300WC Series Ordering Code

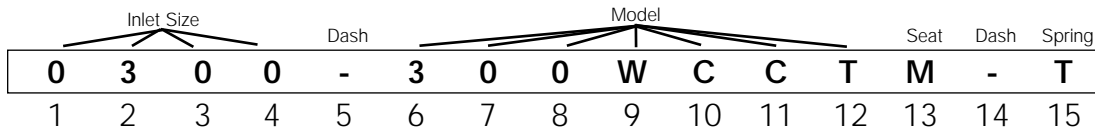

<p>Inlet Size* - Position 1 - 4</p> <p>0200 - 2"</p> <p>0250 - 2½"</p> <p>0300 - 3"</p> <p>0400 - 4"</p> <p>0500 - 5"</p> <p>0600 - 6"</p> <p>Dash - Position 5</p>	<p>Model - Position 6 - 12</p> <p>300WCCT - Cast Steel Body, Stainless Steel Disc</p> <p>300WCTT - Stainless Steel Body, Stainless Steel Disc</p> <p>Seat - Position 13</p> <p>M - Metal</p> <p>Dash - Position 14</p> <p>Spring - Position 15</p> <p>T - Stainless Steel</p>
---	---

300WC SERIES CAST STEEL AND STAINLESS STEEL WAFER SILENT CHECK VALVES

SPECIFICATION

Check Valve shall be single disc design with Cast Steel or Stainless Steel wafer body style designed to ASME Sec. VIII and ASME B16.34. The check valve shall have a SS seat and disc and be center guided from both ends. The check valve shall be ANSI 300 PSIG rated. The spring shall be 316SS. The check valve shall be SSI 300WC Cast Steel or Stainless Steel Series.

MATERIALS OF CONSTRUCTION

Part	Carbon Steel	Stainless Steel
Body	A216-WCB	A351-CF8M
Discs	A351-CF8M	A351-CF8M
Seat	A351-CF8M	A351-CF8M
Spring	316SS	316SS
O-Ring	Viton	Viton

DIMENSIONS inches (mm) AND WEIGHTS pounds (kg)

Size		A	B *	Stud Selection		Length	Weight
				QTY	Dia		
2 (50)	150	2 ⁵ / ₈ (67)	4 ¹ / ₈ (105)	4	⁵ / ₈ (16)	6 ¹ / ₄ (159)	5 (2.3)
	300	2 ⁵ / ₈ (67)	4 ³ / ₈ (111)	8	⁵ / ₈ (16)	6 ¹ / ₂ (165)	5 (2.3)
2 ¹ / ₂ (65)	150	2 ⁷ / ₈ (73)	4 ⁷ / ₈ (124)	4	⁵ / ₈ (16)	6 ³ / ₄ (171)	7 (3.2)
	300	2 ⁷ / ₈ (73)	5 ¹ / ₈ (130)	8	³ / ₄ (19)	7 ¹ / ₄ (184)	7 (3.2)
3 (80)	150	3 ¹ / ₈ (79)	5 ⁷ / ₈ (137)	4	⁵ / ₈ (16)	7 (178)	11 (5.0)
	300	3 ¹ / ₈ (79)	5 ⁷ / ₈ (149)	8	³ / ₄ (19)	7 ³ / ₄ (197)	11 (5.0)
4 (100)	150	4 (102)	6 ⁷ / ₈ (175)	8	⁵ / ₈ (16)	8 (2.3)	20 (9.1)
	300	4 (102)	7 ¹ / ₈ (181)	8	³ / ₄ (19)	9 (229)	20 (9.1)
5 (125)	150	4 ⁵ / ₈ (117)	7 ³ / ₄ (197)	8	³ / ₄ (19)	8.5 (216)	34 (15.4)
	300	4 ⁵ / ₈ (117)	8 ¹ / ₂ (216)	8	³ / ₄ (19)	9 ³ / ₄ (247)	34 (15.4)
6 (150)	150	5 ⁹ / ₁₆ (141)	8 ³ / ₄ (222)	8	³ / ₄ (19)	10 (254)	42 (19.1)
	300	5 ⁹ / ₁₆ (141)	9 ⁷ / ₈ (251)	12	³ / ₄ (19)	10 ³ / ₄ (273)	42 (19.1)

* Add the "B" dimension and the diameter of the stud to achieve the ANSI B16.5 Bolt Hole Circle Diameter.

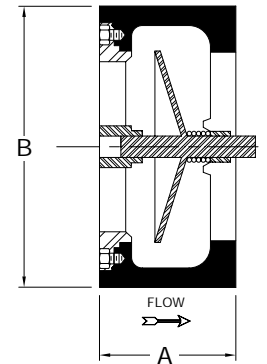
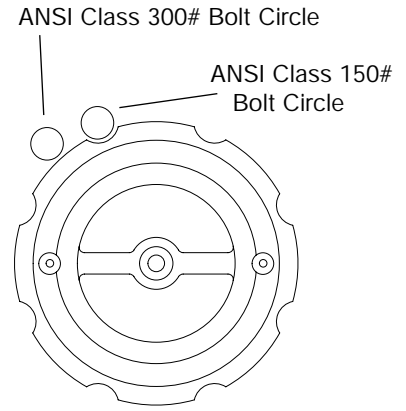

Connections: 2" to 6"
Wafer Flanged RF*

* Sizes 2"-6" are dual rated for 150# and 300# applications and fit between both flanges.

Seats: 2" to 6" Stainless Steel

Cracking Pressure:
Horizontal Mounting - .3 psid
Vertical Mounting - .75 to 1.25 psid

WAFER SILENT
CHECK VALVES

300WC SERIES WAFER SILENT CHECK VALVE

PRESSURE DROP VS FLOW RATE (Sizes 2" - 6")

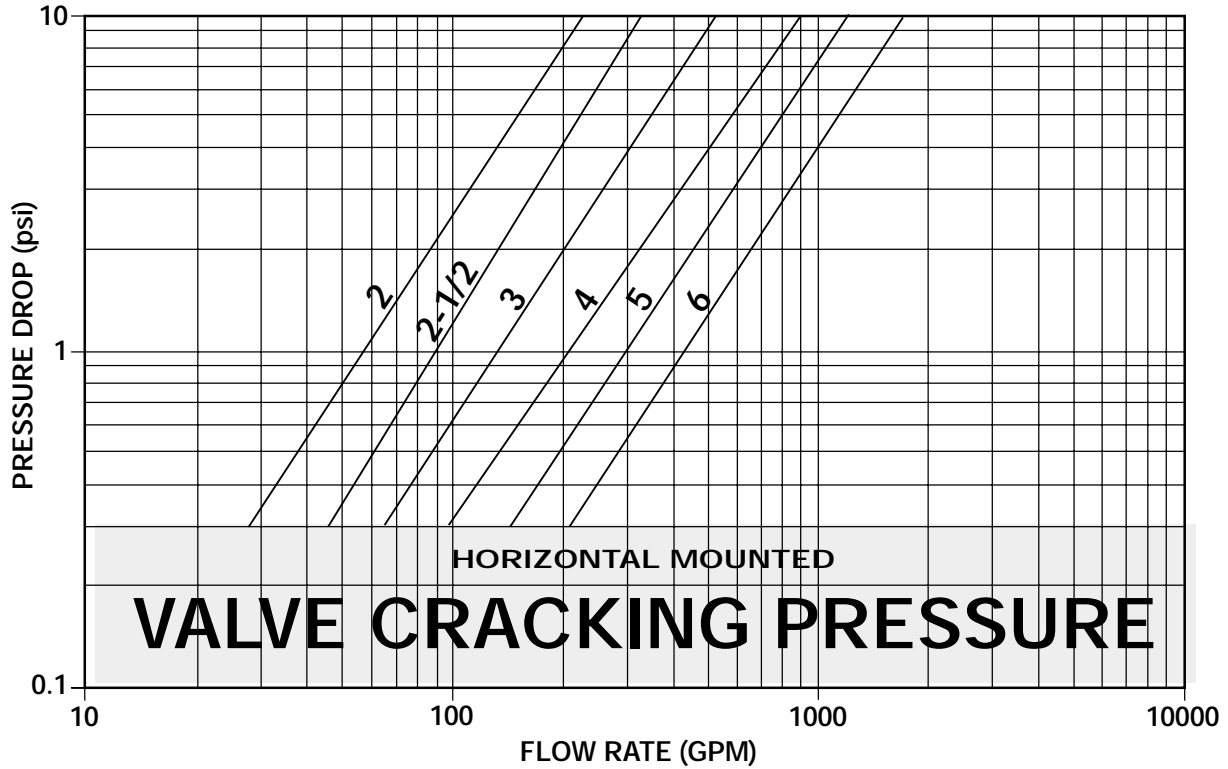

- (1) Pressure drop curves are based on water flow.
- (2) Valve cracking pressure is equal to or less than 0.3 psid when mounted horizontally.
- (3) Valve cracking pressure increases to between 0.75 and 1.25 psid when installed vertically with flow upwards.

Installation Note:

1. For correct installation and maintenance please see our I&M manual.
2. Vertical installation (downward flow) – Consult factory.
3. Always use Strainers in upstream piping.
4. Not recommended for Steam Service

Cv Values

Size (inches)	2	2½	3	4	5	6
Min Cv (@ .3 PSID)	51	84	119	179	265	383
Cv (@ 1 PSID)	58	90	134	210	300	430
Max Cv (@ 10 PSID)	73	106	168	285	391	548



WAFER SILENT CHECK VALVES

INSTALLATION AND MAINTENANCE INSTRUCTIONS

Check valves should be installed, if possible, a minimum of 6 pipe diameters from other line elements, i.e. elbows, pipes, valves, etc.

CHECK VALVE INSTALLATION

- Valves may be installed upward vertically, horizontally, or at other angles. For vertical downward flow please consult with the factory.
- Install the valve with proper positioning of the flow arrow.
- Support and align adjacent piping and the valve
- Install lubricated flange bolts.
- Hand tighten, then torque the bolts using the cross-over flange bolt tightening method to load the bolts evenly, and eliminate concentrated stresses.
- Valves must be mounted to ANSI flanges with conventional flat face or ring gaskets.
- Proper centering of the ring gaskets is important to prevent internal leakage.
- Never lift the valve by the bronze or stainless steel trim.
- Install a strainer in the piping.

PRECAUTIONS

- Do not install check valves directly against another valve whereby the check valve discharges downstream directly into the valve.
- Do not install the valve whereby it directly discharges downstream into a tee or elbow fitting.
- These valves are not suggested for installation in sewage ejector piping.
- Careful consideration should be given to the selection of valves for use in an air, steam, hot water and boiler feed systems. Consult our factory on these applications.
- Individuals performing removal and disassembly should be provided with suitable protection from possibly hazardous liquids.
- Prior to disassembly, valve must first be isolated from system pressure and flow.
- Upon disassembly ensure spring pressure is released slowly to prevent personal injury due to the spring "launching" itself unexpectedly.

WARNING: *This product operates in pipelines or with equipment that carries fluids and/or gasses at elevated temperatures and pressures. Caution should be taken to make sure that this equipment is installed correctly and inspected regularly. Caution should also be taken to protect personnel from fluid or gas leakage.*

NOTES:

WAFER SILENT
CHECK VALVES

