



FTE 10



FTE 14



FTE 43



FTE 44



FTE 44F

### APPLICATIONS

- Very High Condensate Loads
- Continuous Drainage With High Air Venting Capacity Requirements
- Industrial And Commercial Applications
- Absorption Systems
- Air Handling Coils
- Heat Exchangers
- Dryers Evaporators
- Hot water Generators
- Rendering Machines
- Steam Process Equipment
- Air Make-up Coils
- Unit Heaters And Cooking Kettles

### OPTIONS

- BSPT Threaded connection
- S-SLR Orifice on FTE-10
- Socket Weld connection on FTE-44
- Flanged connections
  - ANSI 125/150, 300, 600
  - DIN 10, 16, 25 or 40
  - BS10 - F, H, J, K or R

### OPERATION

During startup, air and non-condensable gases enter the trap and are automatically vented through an accurate balanced pressure internal thermostatic air vent. As condensate enters the trap, the float and lever mechanism is raised,

lifting the valve off the seat, discharging the condensate. Condensate will continue to be discharged at the same rate at which it is entering. Any air or non-condensable gas that may accumulate will be continually and efficiently passed by the thermostatic air vent.

# FTE SERIES FLOAT & THERMOSTATIC STEAM TRAPS

**Pressures to 464 PSIG (32 barg)  
Temperatures to 850°F (454°C)**

- High Capacities
- Rugged cast iron, ductile iron or cast steel body and cover
- Stainless steel thermostatic element eliminates air binding
- Stainless steel float and lever mechanism
- Below condensate level seat design prevents steam leakage
- Resistant to water hammer and corrosion
- In-Line repairable

### MODELS

#### CAST IRON BODY

- FTE-10 – To 200 PSIG Threaded Connections
- FTE-43 – To 200 PSIG Flanged Connections

#### DUCTILE IRON BODY

- FTE-14 – To 200 PSIG Threaded Connections

#### CAST STEEL BODY

- FTE-44 – To 465 PSIG Threaded/Socket Weld Connections
- FTE-44F – To 465 PSIG Flanged Connections

*Installation Tip:* Always install STV Test & Block Valve as part of trap station  
SEE PAGE 118

*Installation Tip:*  
Add Uniflex Pipe Coupling for ease of maintenance on NPT Traps  
SEE PAGE 102

# FTE SERIES FLOAT & THERMOSTATIC STEAM TRAPS

## SPECIFICATION

Steam trap shall be of float and thermostatic design. Float shall actuate the valve via a hinged lever and linkage. Air vent shall be of balanced pressure design with stainless steel welded encapsulated bellows capable of discharging air and noncondensable gases continuously. Trap shall be \_\_\_\_\_ bodied suitable for pressures to \_\_\_\_\_ PSI and shall be a \_\_\_\_\_ connection.

### MAXIMUM OPERATING CONDITIONS

#### CAST IRON/DUCTILE IRON

PMO: Max. Operating Pressure see orifice selection  
 TMO: Max. Operating Temperature saturated at pressure  
 PMA: Max. Allowable Pressure 232 psig (16 barg)  
 PMA: Max. Allowable Pressure 450°F (232°C)

#### CAST STEEL

PMO: Max. Operating Pressure see orifice selection  
 TMO: Max. Operating Temperature saturated at pressure  
 PMA: Max. Allowable Pressure 465 psig (32 barg)  
 TMA: Max. Allowable Pressure 850°F (454°C)

### MATERIALS OF CONSTRUCTION

Body & Cover .....Cast Iron (ASTM A48 Cl. 30)  
 .....Ductile Iron (DIN 1693 GGG 40)  
 .....Cast Steel (ASTM A216 Gr. WCB)  
 Valve .....Stainless Steel 304 (up to 1")  
 .....Stainless Steel 410 (1½", 2")  
 Valve Seat .....Stainless Steel 410  
 Housing & Housing Cover for Float Mechanism .....  
 .....ASTM A743 Gr. CA 40 (Investment Cast)  
 Float .....Stainless Steel 304  
 Lever Assembly .....Stainless Steel 304  
 Thermostatic Airvent .....Stainless Steel 304  
 Cover Bolts .....SAE Gr. 8

Connections:  
 1/2" – 2" NPT, Flanged or Socket Weld

### Maximum Capacity—lbs/hr (10°F Below Saturation)

Trap	Size inlet	Orifice (in.)	Max ΔP		Differential Pressure-PSIG (barg)																
			BAR	PSI	5 (.345)	10 (.690)	20 (1.38)	40 (2.76)	50 (3.45)	65 (4.50)	80 (5.52)	100 (6.90)	125 (8.62)	145 (10.0)	180 (12.4)	200 (13.8)	300 20.7	400 27.6	465 32.1		
FTE-10, 14, & 43	1/2 & 3/4	0.142	4.5	65	400	520	700	950	1000	1150											
		0.095	10.0	145	275	380	530	720	800	900	1000	1080	1250	1380							
		0.079	14.0	200	200	290	400	570	640	700	800	900	1020	1100	1240	1300					
FTE-10, 14, & 43	1	0.256	4.5	65	1650	2200	3050	4200	5000	5200											
		0.17	10.0	145	870	1250	1650	2350	2600	3000	3200	3500	3900	4100							
		0.142	14.0	200	640	800	1250	1600	1800	2000	2200	2550	2780	2900	3020	3100					
FTE-10 & 43	1½	0.689	4.5	65	4200	6000	8800	12500	13500	15000											
		0.571	10.0	145	2800	3900	5600	8000	9000	10000	11500	13000	14200	15000							
		0.531	14.0	200	1800	2600	3600	5000	5450	6000	6900	7800	8600	9000	9650	10000					
FTE-10 & 43	2	1.063	4.5	65	13500	19800	28000	40000	45000	50500											
		0.811	10.0	145	7300	10000	14500	20000	22500	26000	29000	32000	35000	40000							
		0.657	14.0	200	3500	5000	6800	9600	10500	12000	13500	15000	16500	17500	19000	20000					
FTE-44 & 44F	1/2 & 3/4	0.142	4.5	65	400	520	700	950	1000	1150											
		0.095	10.0	145	275	380	530	720	800	900	1000	1080	1250	1380							
		0.079	14.0	200	200	290	400	570	640	700	800	900	1020	1100	1240	1300					
		0.07	21.0	300	110	145	200	280	315	350	400	430	480	520	580	610	700				
		0.063	32.0	465	65	90	120	155	170	200	215	250	280	300	325	345	400	425	440		
FTE-44 & 44F	1	0.256	4.5	65	1650	2200	3050	4200	5000	5200											
		0.17	10.0	145	870	1250	1650	2350	2600	3000	3200	3500	3900	4100							
		0.142	14.0	200	640	800	1250	1600	1800	2000	2200	2550	2780	2900	3020	3100					
		0.114	21.0	300	400	520	700	950	1000	1150	1600	1850	2020	2150	2350	2500	2800				
		0.095	32.0	465	275	380	530	720	800	900	1000	1080	1250	1380	1440	1500	1800	2000	2050		
FTE-44 & 44F	1½	0.689	4.5	65	4200	6000	8800	12500	13500	15000											
		0.571	10.0	145	2800	3900	5600	8000	9000	10000	11500	13000	14200	15000							
		0.531	14.0	200	1800	2600	3600	5000	5450	6000	6900	7800	8600	9000	9650	10000					
		0.531	21.0	300	1800	2600	3600	5000	5450	6000	6900	7800	8600	9000	9650	10000	13000				
		0.531	32.0	465	1800	2600	3600	5000	5450	6000	6900	7800	8600	9000	9650	10000	13000	14300	15000		
FTE-44 & 44F	2	1.063	4.5	65	13500	19800	28000	40000	45000	50500											
		0.811	10.0	145	7300	10000	14500	20000	22500	26000	29000	32000	35000	40000							
		0.657	14.0	200	3500	5000	6800	9600	10500	12000	13500	15000	16500	17500	19000	20000					
		0.657	21.0	300	3500	5000	6800	9600	10500	12000	13500	15000	16500	17500	19000	20000	27000				
		0.657	32.0	465	3500	5000	6800	9600	10500	12000	13500	15000	16500	17500	19000	20000	27000	29800	31000		

For Kg/Hr Multiply by .454

# SERIES FTE DIMENSIONS

## DIMENSIONS inches (mm) AND WEIGHTS pounds (kg) SERIES FTE-10 & FTE 44

Size	Inches (mm)						Weight Lbs(kg)	
	A	B	C	D	E	F	FTE-10	FTE-44
1/2	5 <sup>1</sup> / <sub>16</sub> (128)	2 <sup>1</sup> / <sub>8</sub> (54)	2 <sup>1</sup> / <sub>8</sub> (54)	5 <sup>1</sup> / <sub>16</sub> (145)	4 <sup>9</sup> / <sub>16</sub> (110)	6 <sup>1</sup> / <sub>16</sub> (170)	10.5 (4.8)	11.4 (5.2)
3/4	5 <sup>1</sup> / <sub>16</sub> (128)	2 <sup>1</sup> / <sub>8</sub> (54)	2 <sup>1</sup> / <sub>8</sub> (54)	5 <sup>1</sup> / <sub>16</sub> (145)	4 <sup>9</sup> / <sub>16</sub> (110)	6 <sup>1</sup> / <sub>16</sub> (170)	10.5 (4.8)	11 (5.0)
1	5 <sup>1</sup> / <sub>16</sub> (128)	4 <sup>9</sup> / <sub>16</sub> (110)	2 <sup>1</sup> / <sub>8</sub> (75)	7 <sup>1</sup> / <sub>2</sub> (190)	6 <sup>9</sup> / <sub>16</sub> (160)	8 <sup>1</sup> / <sub>2</sub> (216)	18.7 (8.5)	17.6 (8.0)
1 <sup>1</sup> / <sub>2</sub>	11 <sup>1</sup> / <sub>8</sub> (282)	5 (127)	4 <sup>9</sup> / <sub>16</sub> (110)	10 (254)	7 <sup>7</sup> / <sub>8</sub> (200)	11 <sup>3</sup> / <sub>8</sub> (289)	49.5 (22.5)	48.4 (22.0)
2	12 <sup>1</sup> / <sub>8</sub> (308)	5 <sup>1</sup> / <sub>2</sub> (140)	5 (127)	10 <sup>1</sup> / <sub>4</sub> (260)	7 <sup>7</sup> / <sub>8</sub> (200)	11 <sup>13</sup> / <sub>16</sub> (300)	61.6 (28.0)	59.4 (27.0)

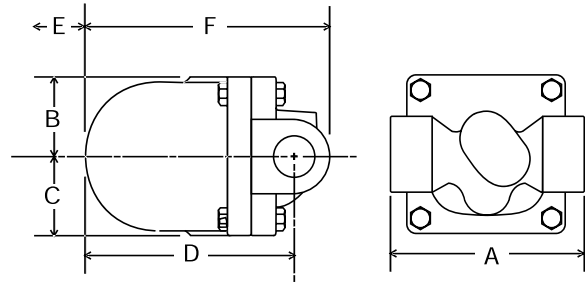

FTE-10 CAST IRON & FTE-44 CAST STEEL 1/2" & 3/4"

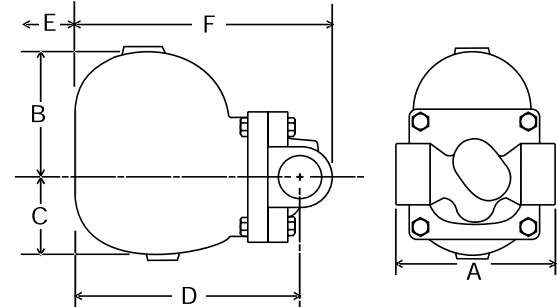

FTE-10 CAST IRON & FTE-44 CAST STEEL 1"

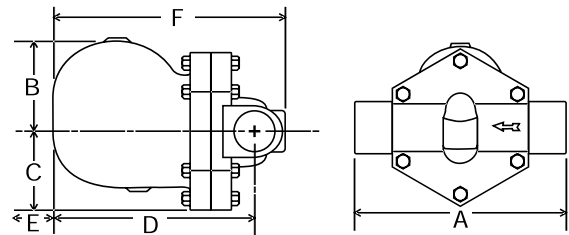

FTE-10 CAST IRON & FTE-44 CAST STEEL 1 1/2" & 2"

## DIMENSIONS inches (mm) AND WEIGHTS pounds (kg) SERIES FTE-14

Size	Inches (mm)				Weight lbs. (kg)
	A	B	C	D	
1/2	4 <sup>3</sup> / <sub>8</sub> (121)	4 <sup>1</sup> / <sub>4</sub> (108)	2 <sup>5</sup> / <sub>8</sub> (67)	5 <sup>1</sup> / <sub>16</sub> (148)	7.9 (3.6)
3/4	4 <sup>3</sup> / <sub>8</sub> (121)	4 <sup>1</sup> / <sub>4</sub> (108)	2 <sup>5</sup> / <sub>8</sub> (67)	5 <sup>1</sup> / <sub>16</sub> (148)	7.9 (3.6)
1	5 <sup>1</sup> / <sub>16</sub> (145)	4 <sup>1</sup> / <sub>4</sub> (108)	3 (76)	6 <sup>5</sup> / <sub>16</sub> (167)	10.1 (4.6)

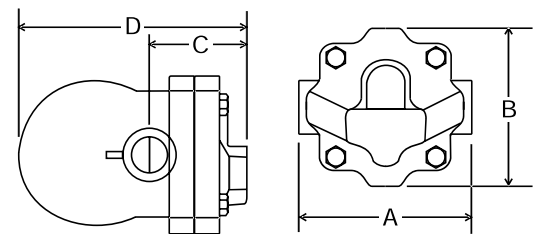

FTE-14-DUCTILE IRON 1/2", 3/4" & 1"

# SERIES FTE DIMENSIONS

**DIMENSIONS** inches (mm)  
**AND WEIGHTS** pounds (kg)  
**SERIES FTE-43**

Size	Inches (mm)					Weight Lbs. (kg)
	A	B	C	D	E	
1/2	5 <sup>7</sup> / <sub>16</sub> (150)	2 <sup>1</sup> / <sub>16</sub> (54)	2 <sup>1</sup> / <sub>16</sub> (54)	7 <sup>1</sup> / <sub>2</sub> (190)	4 <sup>5</sup> / <sub>16</sub> (110)	15.4 (7.0)
3/4	5 <sup>7</sup> / <sub>16</sub> (150)	2 <sup>1</sup> / <sub>16</sub> (54)	2 <sup>1</sup> / <sub>16</sub> (54)	7 <sup>7</sup> / <sub>16</sub> (192)	4 <sup>5</sup> / <sub>16</sub> (110)	16.5 (7.5)
1	6 <sup>7</sup> / <sub>16</sub> (160)	4 <sup>5</sup> / <sub>16</sub> (110)	2 <sup>1</sup> / <sub>16</sub> (75)	9 <sup>1</sup> / <sub>16</sub> (245)	6 <sup>5</sup> / <sub>16</sub> (160)	25.3 (11.5)
1 1/2	9 <sup>1</sup> / <sub>16</sub> (230)	5 (127)	4 <sup>5</sup> / <sub>16</sub> (110)	13 <sup>3</sup> / <sub>16</sub> (333)	7 <sup>7</sup> / <sub>16</sub> (200)	61.6 (28.0)
2	9 <sup>1</sup> / <sub>16</sub> (230)	5 1/2 (140)	5 (127)	13 1/2 (343)	7 <sup>7</sup> / <sub>16</sub> (200)	74.8 (34.0)

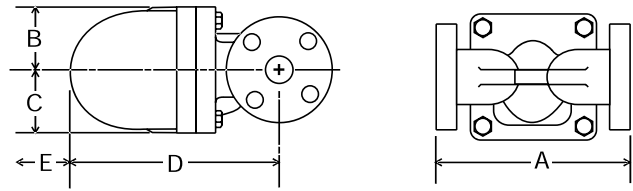

FTE-43 CAST IRON 1/2" & 3/4"

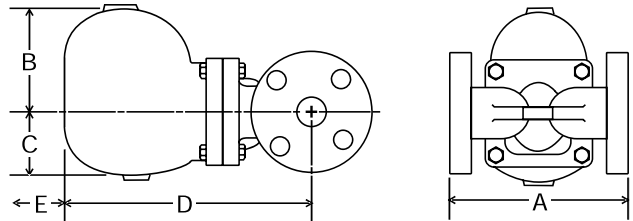

FTE-43 CAST IRON 1"

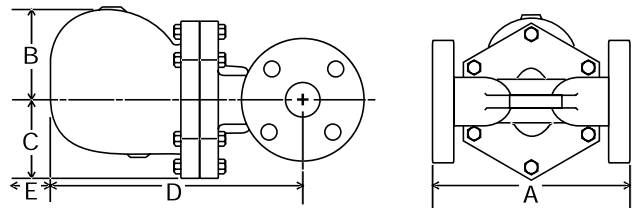

FTE-43 CAST IRON 1 1/2" & 2"

**DIMENSIONS** inches (mm)  
**AND WEIGHTS** pounds (kg)  
**SERIES FTE-44F**

Size	Inches (mm)					Weight Lbs. (kg)
	A	B	C	D	E	
1/2	8 <sup>1</sup> / <sub>4</sub> (210)	2 <sup>1</sup> / <sub>16</sub> (54)	2 <sup>1</sup> / <sub>16</sub> (54)	5 <sup>5</sup> / <sub>16</sub> (141)	4 <sup>5</sup> / <sub>16</sub> (110)	16.5 (7.5)
3/4	8 <sup>1</sup> / <sub>4</sub> (210)	2 <sup>1</sup> / <sub>16</sub> (54)	2 <sup>1</sup> / <sub>16</sub> (54)	5 <sup>5</sup> / <sub>16</sub> (141)	4 <sup>5</sup> / <sub>16</sub> (110)	17.6 (8.0)
1	8 <sup>1</sup> / <sub>4</sub> (210)	4 <sup>5</sup> / <sub>16</sub> (110)	2 <sup>1</sup> / <sub>16</sub> (75)	7 <sup>1</sup> / <sub>2</sub> (190)	6 <sup>5</sup> / <sub>16</sub> (160)	25.3 (11.5)
1 1/2	12 <sup>1</sup> / <sub>16</sub> (325)	5 (127)	4 <sup>5</sup> / <sub>16</sub> (110)	9 <sup>5</sup> / <sub>16</sub> (245)	7 <sup>7</sup> / <sub>16</sub> (200)	60.5 (27.5)
2	12 <sup>1</sup> / <sub>16</sub> (325)	5 1/2 (140)	5 (127)	9 <sup>5</sup> / <sub>16</sub> (251)	7 <sup>7</sup> / <sub>16</sub> (200)	74.8 (34.0)

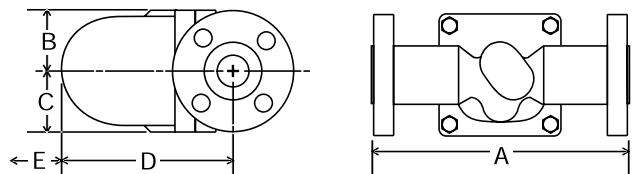

FTE-44F CAST STEEL 1/2" & 3/4"

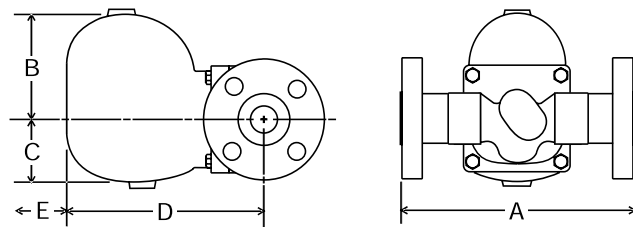

FTE-44F CAST STEEL 1"

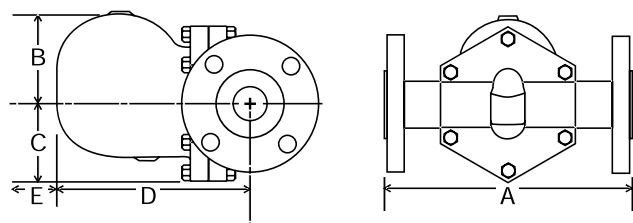

FTE-44F CAST STEEL 1 1/2" & 2"